

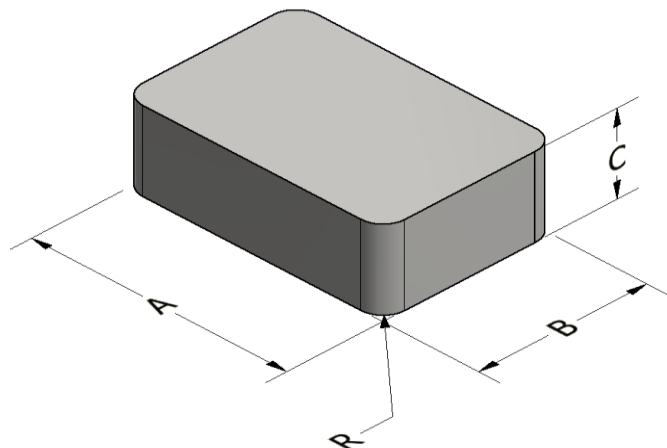

Part Number: **BMS-0803015-060**

Revision 20160414 - Generated 2016-Apr-28



A	80.00 ± 0.50 mm	3.150 ± 0.020 in
B	30.00 ± 0.50 mm	1.181 ± 0.020 in
C	15.00 ± 0.50 mm	0.591 ± 0.020 in
R	1.5 ± 0.50 mm	0.059 ± 0.020 in
	μ_i (reference)	60
Mass	(approximate)	210 grams
Core Loss	$\text{Core Loss (mW/cm}^3\text{)} = \frac{a}{B_{pk}^3} + \frac{b}{B_{pk}^{2.3}} + \frac{c}{B_{pk}^{1.65}} + d \cdot B_{pk}^2 \cdot f^2$	
	where B_{pk} expressed in gauss, f expressed in hertz, and: $a=7.89E+09$, $b=7.11E+08$, $c=8.98E+06$, $d=2.85E-14$	
	B_{pk}	1000 G
	frequency	50 kHz
	Core Loss (nominal)	323 mW/cm ³
Core Loss (maximum)	372 mW/cm ³	
DC Saturation	$\% \mu_i = \frac{1}{a + b \cdot H^c} + d$	
	where H expressed in oersteds, and: $a=0.01$, $b=4.47E-06$, $c=1.74$, $d=0.00$	
	H_{DC}	100 Oe
	Percent Initial Perm(nom.)	42.2%
	Percent Initial Perm(min.)	34.7%
Coating/Pkg	Coating Type:	None
	Voltage Breakdown (min.)	N/A
	Limit	N/A
	Package Quantity	75 Pieces/Box

