

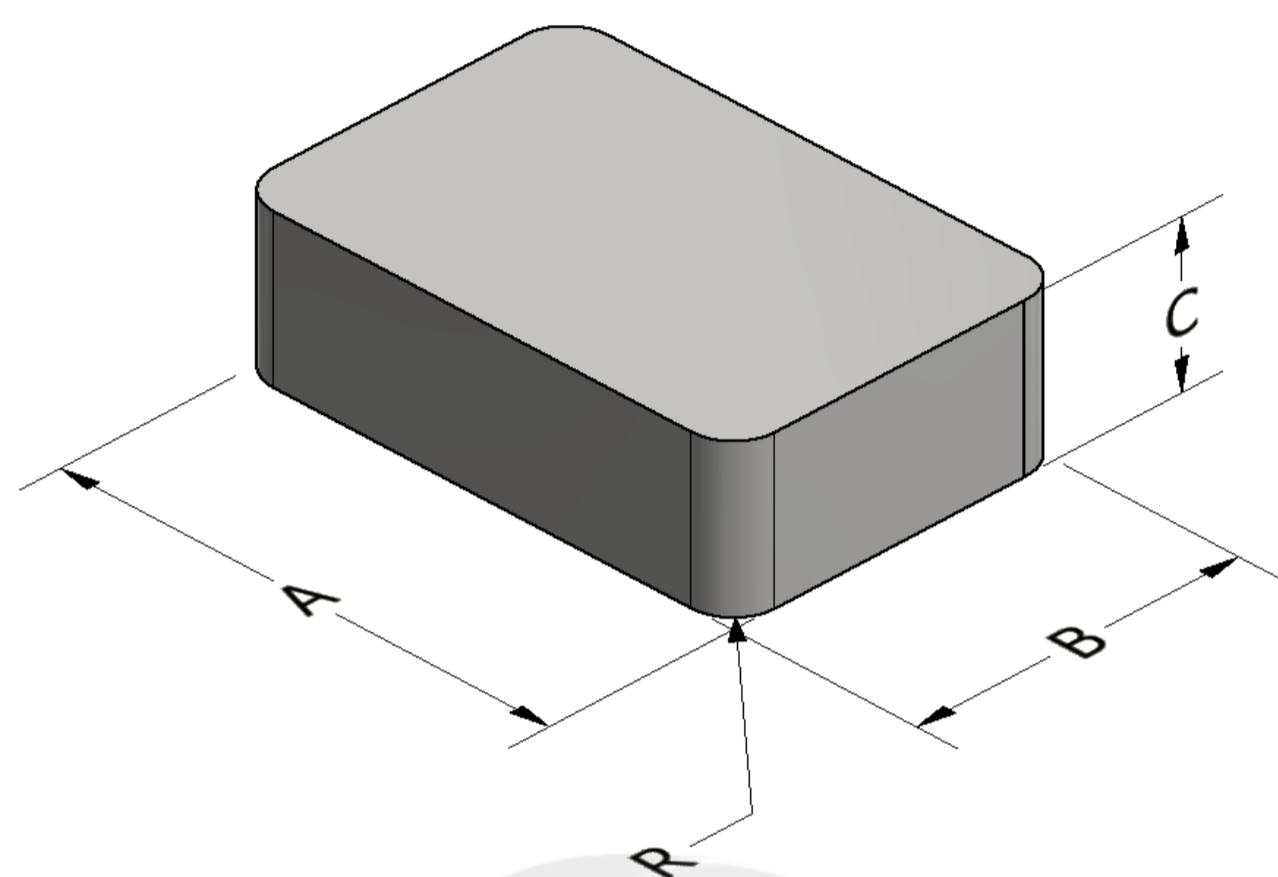

**Part Number:** **BFS-0803015-060**

Revision 20190529 - Generated 2019-May-29



<b>A</b>	80.00 ± 0.50 mm	3.150 ± 0.020 in
<b>B</b>	30.00 ± 0.50 mm	1.181 ± 0.020 in
<b>C</b>	15.00 ± 0.50 mm	0.591 ± 0.020 in
<b>R</b>	1.5 ± 0.50 mm	0.059 ± 0.020 in
	$\mu_i$ (reference)	60
<b>Mass</b>	(approximate)	240 grams
<b>Core Loss</b>	$\text{Core Loss (mW/cm}^3\text{)} = \frac{f}{\frac{a}{Bpk^3} + \frac{b}{Bpk^{2.3}} + \frac{c}{Bpk^{1.65}}} + d \cdot Bpk^2 \cdot f^2$	
	where $B_{pk}$ expressed in gauss, $f$ expressed in hertz, and: $a=6.42E+08$ , $b=3.00E+08$ , $c=1.69E+06$ , $d=5.56E-14$	
	$B_{pk}$	1000 G
	frequency	50 kHz
	Core Loss (nominal)	1,011 mW/cm <sup>3</sup>
	Core Loss (maximum)	1,163 mW/cm <sup>3</sup>
<b>DC Saturation</b>	$\% \mu_i = \frac{1}{a + b \cdot H^c} + d$	
	where H expressed in oersteds, and: $a=0.01$ , $b=4.05E-06$ , $c=1.57$ , $d=0.00$	
	$H_{DC}$	150 Oe
	Percent Initial Perm(nom.)	48.5%
	Percent Initial Perm(min.)	41.4%
<b>Coating/Pkg</b>	Coating Type:	None
	Voltage Breakdown (min.)	N/A
	Limit	N/A
	Package Quantity	75 Pieces/Box

