

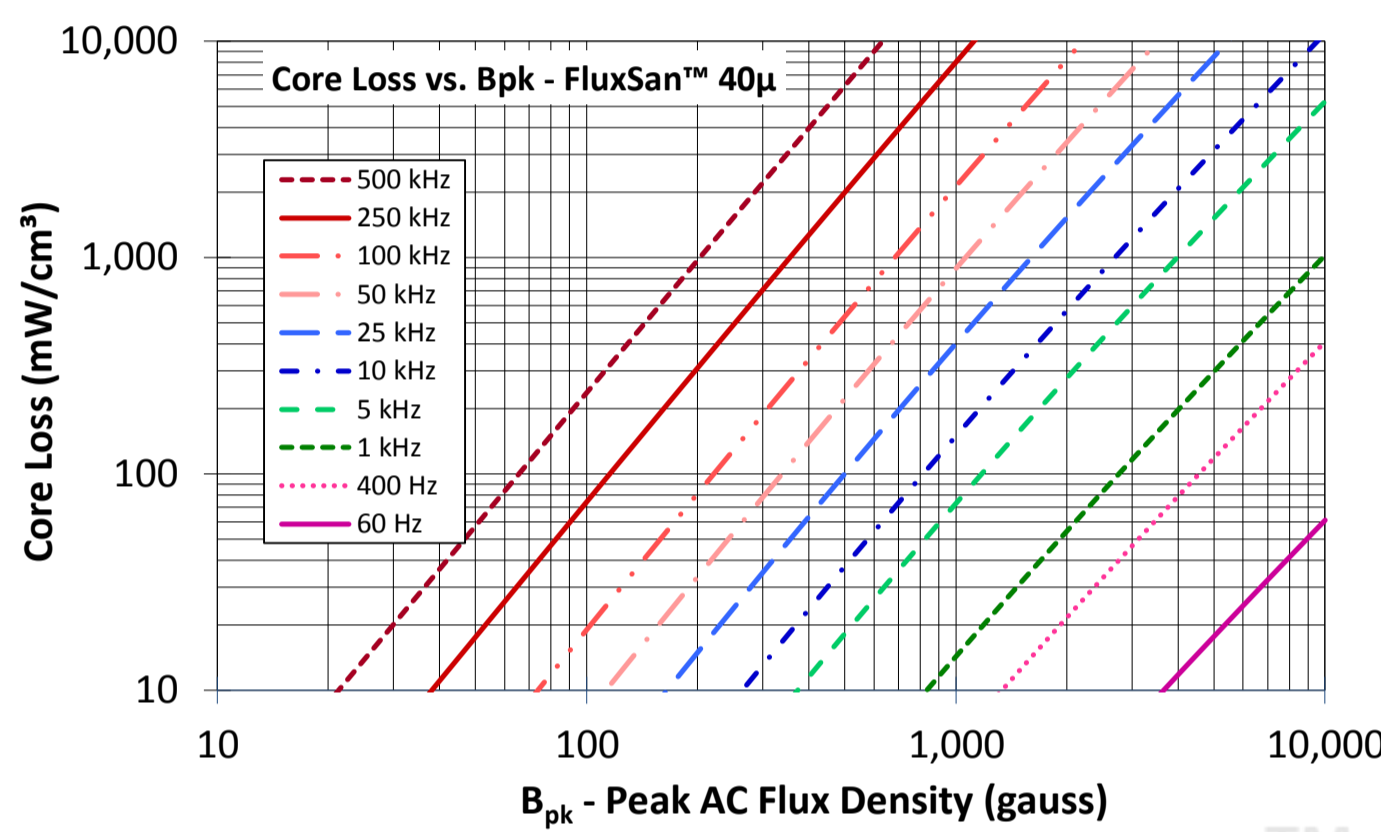

**Part Number:** **BFS-0803015-040**

Revision 20190529 - Generated 2019-May-29

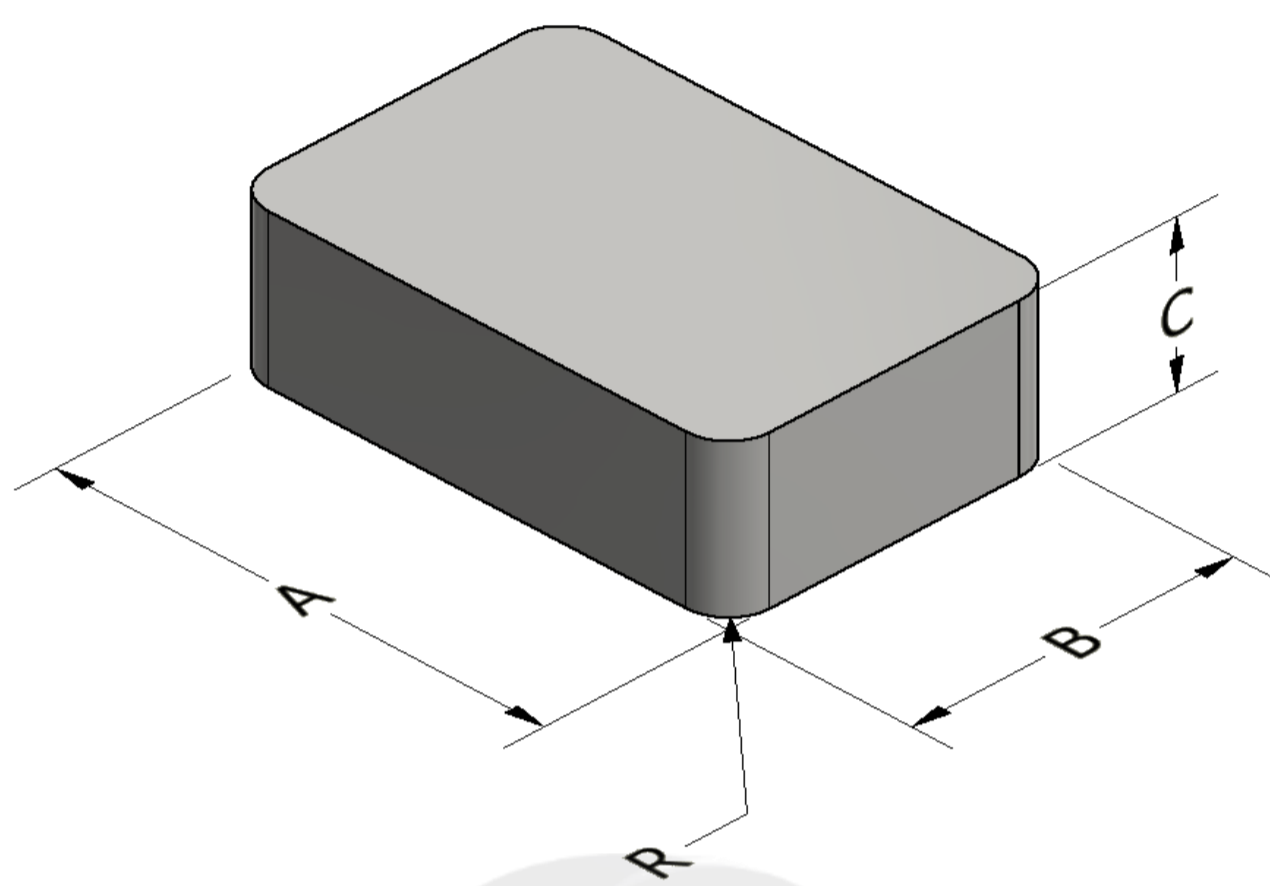

<b>A</b>	80.00 ± 0.50 mm	3.150 ± 0.020 in
<b>B</b>	30.00 ± 0.50 mm	1.181 ± 0.020 in
<b>C</b>	15.00 ± 0.50 mm	0.591 ± 0.020 in
<b>R</b>	1.5 ± 0.50 mm	0.059 ± 0.020 in
	$\mu_i$ (reference)	40
<b>Mass</b>	(approximate)	230 grams
<b>Core Loss</b>	$\text{Core Loss (mW/cm}^3\text{)} = \frac{f}{\frac{a}{Bpk^3} + \frac{b}{Bpk^{2.3}} + \frac{c}{Bpk^{1.65}}} + d \cdot Bpk^2 \cdot f^2$	
	where $B_{pk}$ expressed in gauss, $f$ expressed in hertz, and: $a=1.00E+06$ , $b=2.70E+08$ , $c=3.23E+06$ , $d=7.09E-14$	
	$B_{pk}$	1000 G
	frequency	50 kHz
	Core Loss (nominal)	889 mW/cm <sup>3</sup>
Core Loss (maximum)	1,022 mW/cm <sup>3</sup>	
<b>DC Saturation</b>	$\% \mu_i = \frac{1}{a + b \cdot H^c} + d$	
	where $H$ expressed in oersteds, and: $a=0.01$ , $b=1.53E-06$ , $c=1.62$ , $d=0.00$	
	$H_{DC}$	100 Oe
	Percent Initial Perm(nom.)	79.0%
Percent Initial Perm(min.)	73.7%	
<b>Coating/Pkg</b>	Coating Type:	None
	Voltage Breakdown (min.)	N/A
	Limit	N/A
	Package Quantity	75 Pieces/Box

