

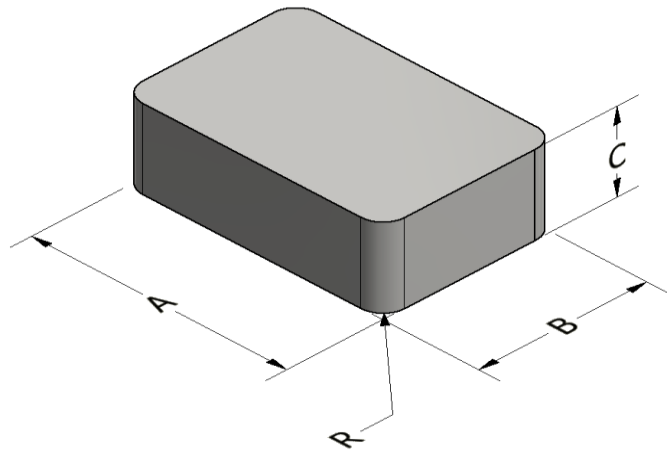

Part Number: BFS-0703025-014

Revision 20160414 - Generated 2016-Apr-28



A	70.00 ± 0.50 mm	2.756 ± 0.020 in
B	30.00 ± 0.50 mm	1.181 ± 0.020 in
C	25.00 ± 0.50 mm	0.984 ± 0.020 in
R	1.5 ± 0.50 mm	0.059 ± 0.020 in
	μ_i (reference)	14
Mass	(approximate)	300 grams
Core Loss	$\text{Core Loss (mW/cm}^3\text{)} = \frac{a}{B_{pk}^3} + \frac{b}{B_{pk}^{2.3}} + \frac{c}{B_{pk}^{1.65}} + d \cdot B_{pk}^2 \cdot f^2$	
	where B_{pk} expressed in gauss, f expressed in hertz, and: $a=1.00E+06$, $b=7.92E+07$, $c=2.34E+06$, $d=5.39E-14$	
	B_{pk}	300 G
	frequency	100 kHz
	Core Loss (nominal)	334 mW/cm ³
Core Loss (maximum)	384 mW/cm ³	
DC Saturation	$\% \mu_i = \frac{1}{a + b \cdot H^c} + d$	
	where H expressed in oersteds, and: $a=0.01$, $b=1.80E-07$, $c=1.55$, $d=0.00$	
	H_{DC}	200 Oe
	Percent Initial Perm(nom.)	93.7%
	Percent Initial Perm(min.)	91.8%
Coating/Pkg	Coating Type:	None
	Voltage Breakdown (min.)	N/A
	Limit	N/A
	Package Quantity	45 Pieces/Box

