

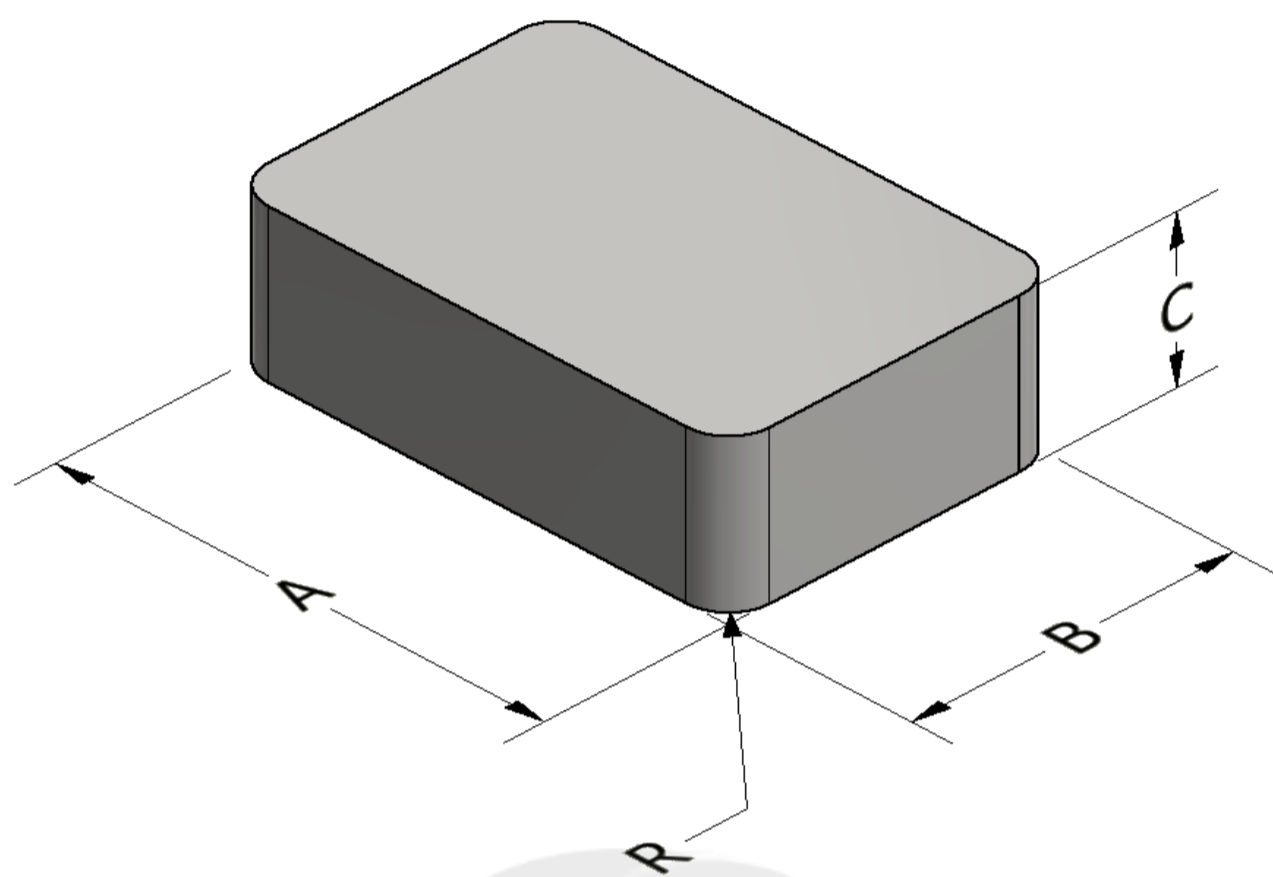

Part Number: **BFS-0603015-060**

Revision 20190529 - Generated 2019-May-29



A	60.00 ± 0.50 mm	2.362 ± 0.020 in
B	30.00 ± 0.50 mm	1.181 ± 0.020 in
C	15.00 ± 0.50 mm	0.591 ± 0.020 in
R	1.5 ± 0.50 mm	0.059 ± 0.020 in
	μ_i (reference)	60
Mass	(approximate)	180 grams
Core Loss	$\text{Core Loss (mW/cm}^3\text{)} = \frac{f}{\frac{a}{Bpk^3} + \frac{b}{Bpk^{2.3}} + \frac{c}{Bpk^{1.65}}} + d \cdot Bpk^2 \cdot f^2$	
	where B_{pk} expressed in gauss, f expressed in hertz, and: $a=6.42E+08$, $b=3.00E+08$, $c=1.69E+06$, $d=5.56E-14$	
	B_{pk}	1000 G
	frequency	50 kHz
	Core Loss (nominal)	1,011 mW/cm ³
	Core Loss (maximum)	1,163 mW/cm ³
DC Saturation	$\% \mu_i = \frac{1}{a + b \cdot H^c} + d$	
	where H expressed in oersteds, and: $a=0.01$, $b=4.05E-06$, $c=1.57$, $d=0.00$	
	H_{DC}	150 Oe
	Percent Initial Perm(nom.)	48.5%
	Percent Initial Perm(min.)	41.4%
Coating/Pkg	Coating Type:	None
	Voltage Breakdown (min.)	N/A
	Limit	N/A
	Package Quantity	75 Pieces/Box

